

## Montagem do sistema de porta

Freio  
Fixar com Parafuso 3,5x25 cab  
flange(C )

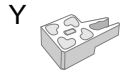

Carro deslizador

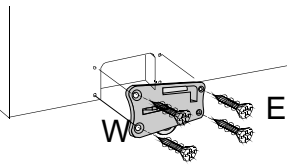

Guia  
Parafuso 3,5x 20 cab  
chata (D)

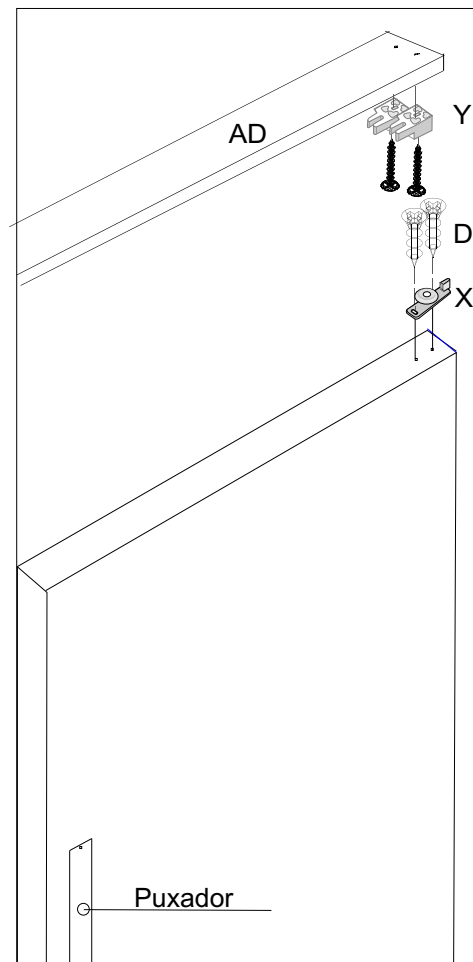
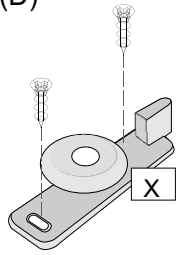

## Puppi Móbile

Rua Ema Tanner de Andrade, 965  
Vila Ferrari - Campo Largo - Paraná  
e-mail: puppimobile@puppimobile.com.br

## MANUAL DE INSTRUÇÕES

Roupeiro White 1,80  
REF.: 10628

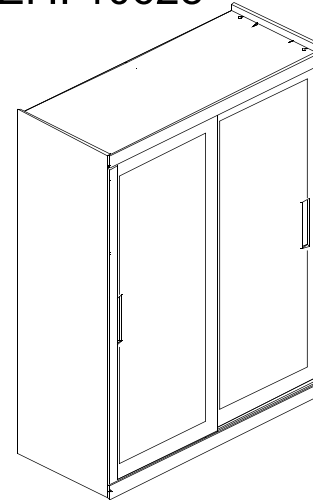

**PUPPI**  
MOBILE

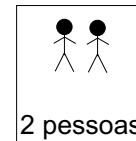

2 pessoas

















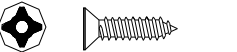







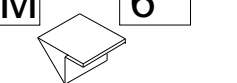



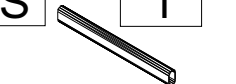

Aproximadamente:  
2 horas

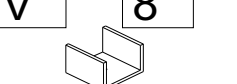

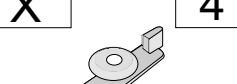
Vol. 4

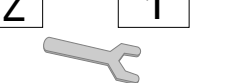
Medida A 1807 L/C 2250 P598

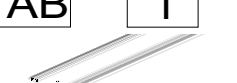
1. Leia atentamente todo o manual de instruções antes de iniciar a montagem.
2. A montagem do produto deverá ser feita em superfície limpa e plana. Aconselhamos utilizar a própria embalagem para forrar o chão a fim de não danificar o produto.
3. Reservar área livre p/ montagem do produto.
4. Evitar batidas e contato com objetos cortantes.

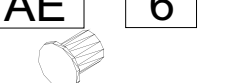
|  |   |   |   |
|--|---|---|---|
| <b>A</b> 12  | <b>B</b> 6  | <b>C</b> 10   | <b>D</b> 14   |
|  Paraf. 4,0x45 cab chata       |  Paraf. 3,5x35 cab flange          |  Paraf. 3,5x25 cab flange    |  Paraf. 3,5x20 cab chata        |
| <b>E</b> 89  | <b>F</b> 2  | <b>G</b> 30   | <b>H</b> 4  |
|  Paraf. 4,0x14cab chata        |  Paraf. minifix duplo              |  Paraf. minifix m6x7,5       |  Parafuso M4 x10 cab. Flange    |
| <b>I</b> 30  | <b>J</b> 34   | <b>K</b> 34   | <b>L</b> 2  |
|  Bucha minifix                 |  Tampa minifix                     |  Tambor minifix              |  Suporte cabideiro              |
| <b>M</b> 6   | <b>N</b> 12   | <b>O</b> 2  | <b>P</b> 40   |
|  Fixador fundo de gaveta       |  Corrediça telescópica 400mm (PAR) |  Trapézio                    |  Fixador para costa de roupeiro |
| <b>Q</b> 98  | <b>R</b> 120  | <b>S</b> 1  | <b>T</b> 2  |
|  Cavilha 8x40                  |  Pregos 8x8mm                      |  Tubo oblongo 872mm          |  Puxador 256mm                  |
| <b>U</b> 2   | <b>V</b> 8  | <b>W</b> 4  | <b>X</b> 4  |
|  Sachê de cola                 |  Sapata "U" 15mm                   |  Kit sistema porta de correr |  Guia                           |
| <b>Y</b> 4   | <b>Z</b> 1  | <b>AA</b> 4   | <b>AB</b> 1   |
|  Freio                        |  Chave de boca                    |  Perfil desempenador 2090mm |  Trilho inferior med. 1769mm   |
| <b>AC</b> 1  | <b>AD</b> 9   | <b>AE</b> 6   |   |
|  Trilho superior med. 1769mm |  Cantoneira                      |  Tapa furo 10mm            |   |

### Colocar vista superior ( 20 )

- colocar cavilhas e minifix nas extremidades da vista
- Colocar vista inferior ( 21 ) e vista lateral ( 22 ) com cavilha ( Q ) e cola ( U )

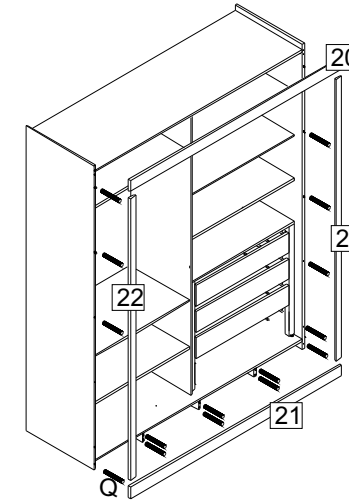

### -montagem de gavetas

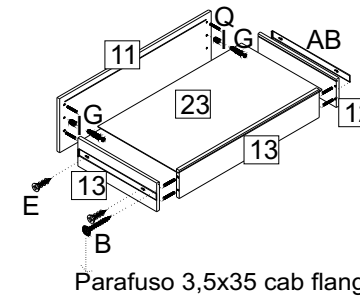

Parafuso 3,20 cab chata (D)

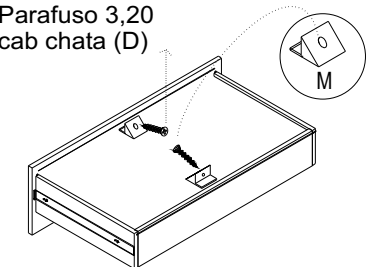

Parafuso 3,5x35 cab flange(B)

### -Portas

Colocar perfil desempenador (AA) nas portas com parafusos 4x14 cab chata (E)  
Puxador (T) com parafuso (H)

Ao colocar o puxador, utilizar parafuso H.

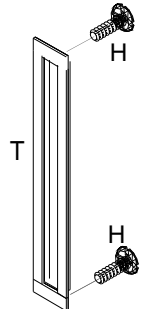
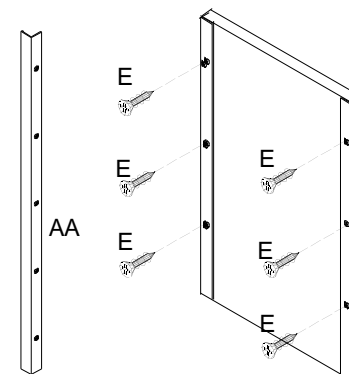

### Montar o roupeiro.

- iniciar com uma das laterais
- montar com a parte de trás para cima

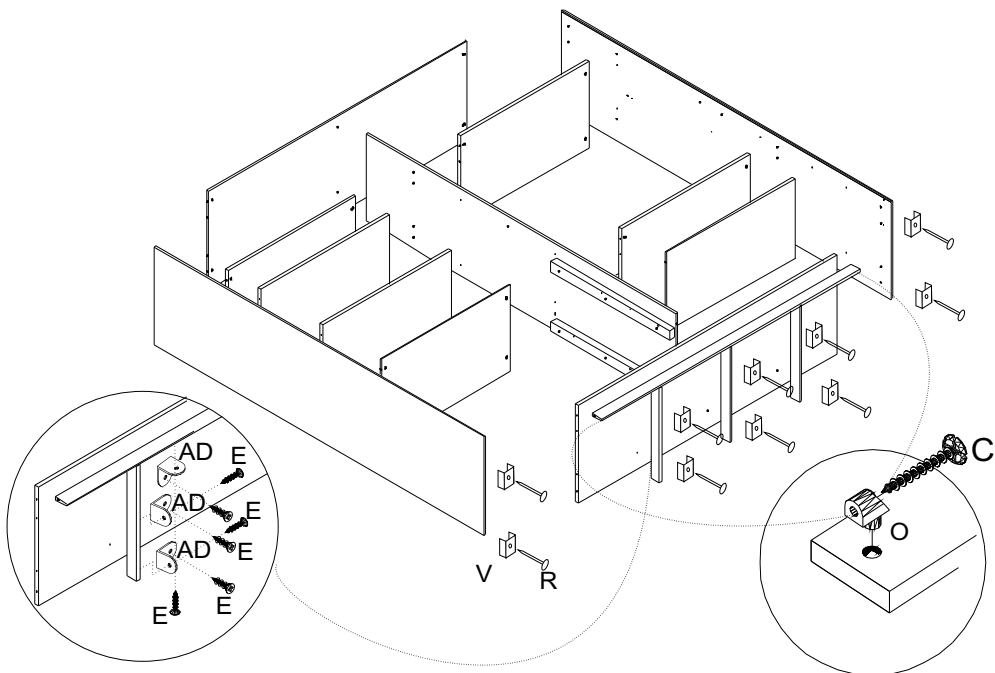

### Fixar encosto horizontal(25) e vertical(24)

- usar pregos (R) e fixador de encosto (P)
- deixar espaçamento de 12 cm de um prego ao outro.

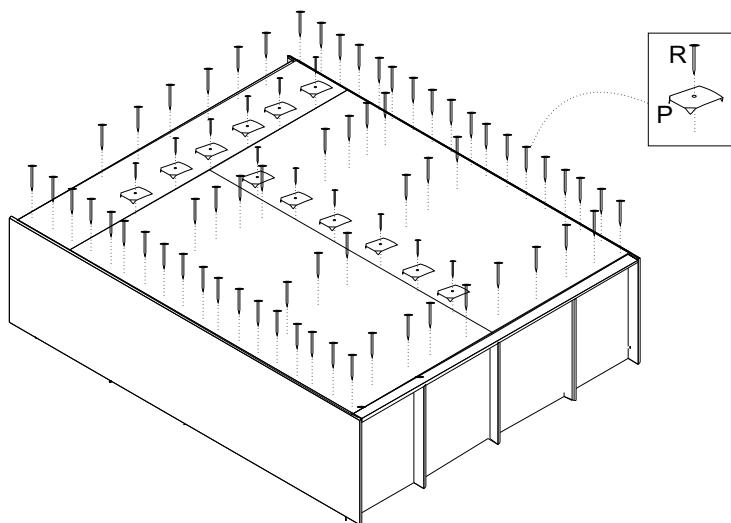

### LISTA DE PEÇAS

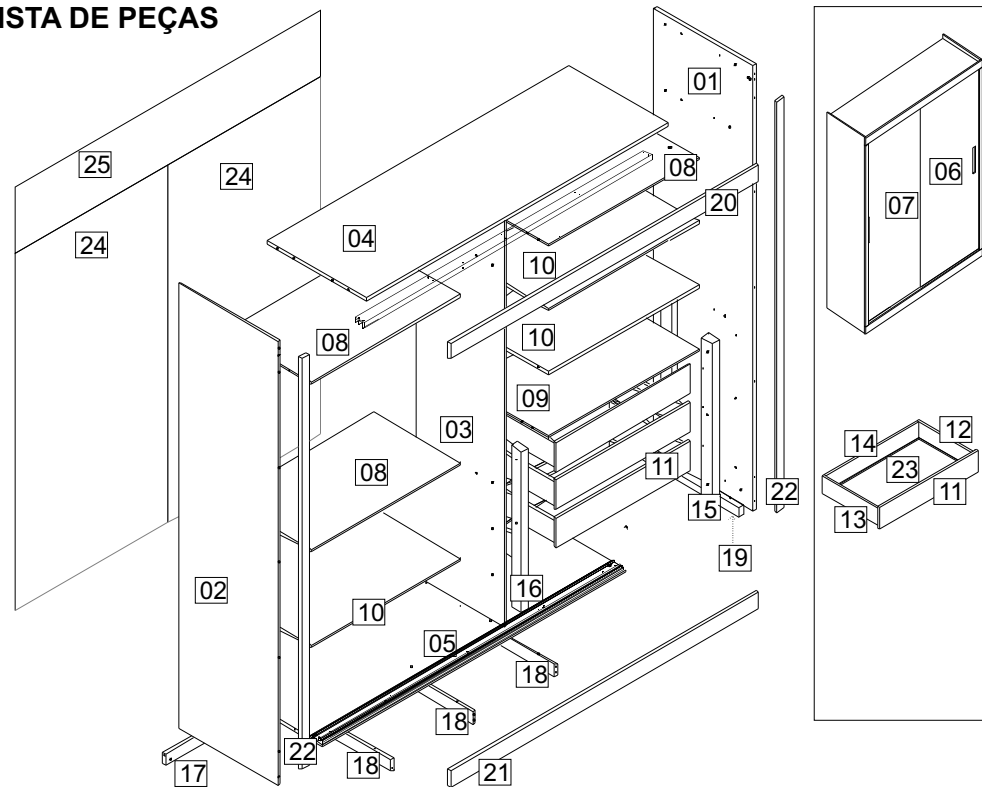

| item | COMPONENTES                                 | quant |
|------|---|-------|
| 1    | LATERAL direita                             | 1     |
| 2    | LATERAL esquerda                            | 1     |
| 3    | DIVISÓRIA central                           | 1     |
| 4    | CHAPÉU                                      | 1     |
| 5    | BASE  | 1     |
| 6    | PORTA direita                               | 1     |
| 7    | PORTA esquerda                              | 1     |
| 8    | PRATELEIRA fixa c/ mini fix                 | 3     |
| 09   | PRATELEIRA fixa c/ mini fixc- sobre gavetas | 1     |
| 10   | PRATELEIRA c/ cavilha                       | 3     |
| 11   | FRENTE de gaveta                            | 3     |
| 12   | LATERAL direita de gaveta                   | 3     |
| 13   | LATERAL esquerda de gaveta                  | 3     |
| 14   | TRASEIRA de gaveta                          | 3     |
| 15   | MONTANTE distanciador de corrediça direita  | 2     |
| 16   | MONTANTE distanciador de corrediça esquerda | 2     |
| 17   | RODAPÉ traseiro                             | 1     |
| 18   | REFORÇO RODAPÉ                              | 3     |
| 19   | REFORÇO para base                           | 2     |
| 20   | VISTA superior                              | 1     |
| 21   | VISTA inferior                              | 1     |
| 22   | VISTA lateral                               | 2     |
| 23   | FUNDO gaveta                                | 3     |
| 24   | ENCOSTO vertical                            | 2     |
| 25   | ENCOSTO horizontal                          | 1     |

### Montar Lateral direita ( 01 )

usar parafuso minifix (G) bucha (I) parafuso 4,0x45 cab chata (A)

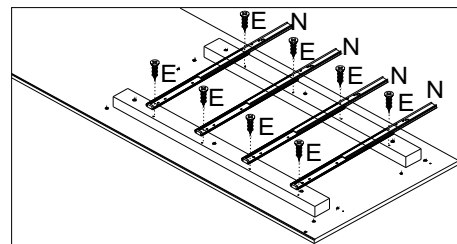
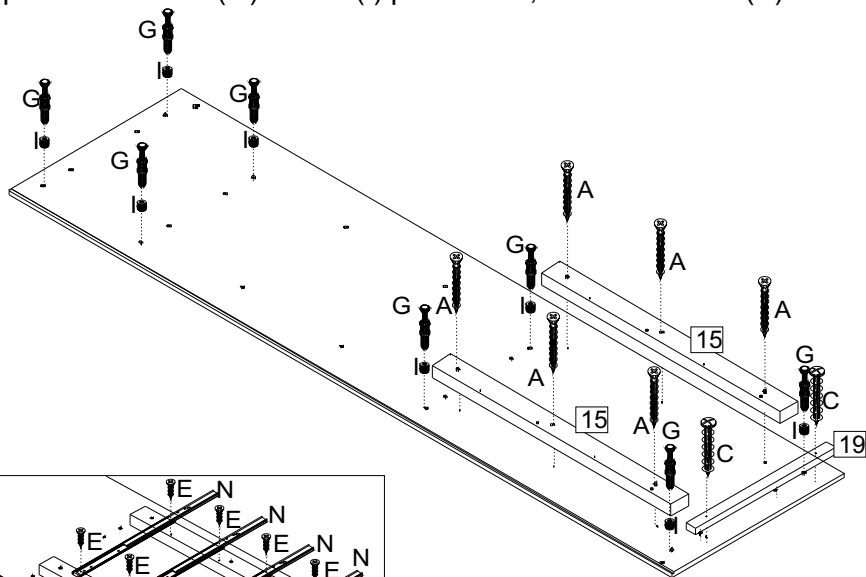

### Montar Lateral esquerda ( 02 )

usar parafuso minifix (G), bucha (I) e parafuso 3,5x25 cab flange (C)

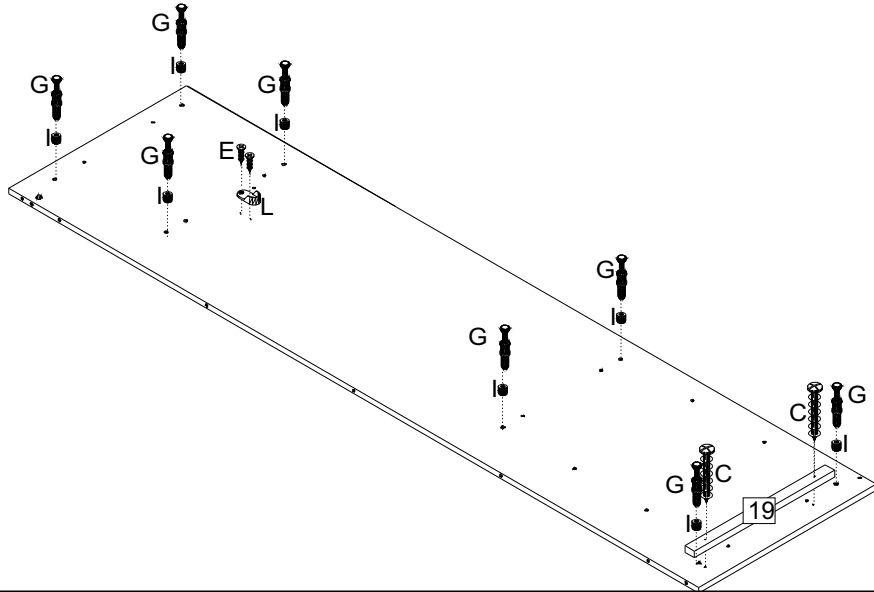

### Montar divisória direita (03) lado direito e esquerdo

-fixar ferragens no lado direito e esquerdo

- lado direito

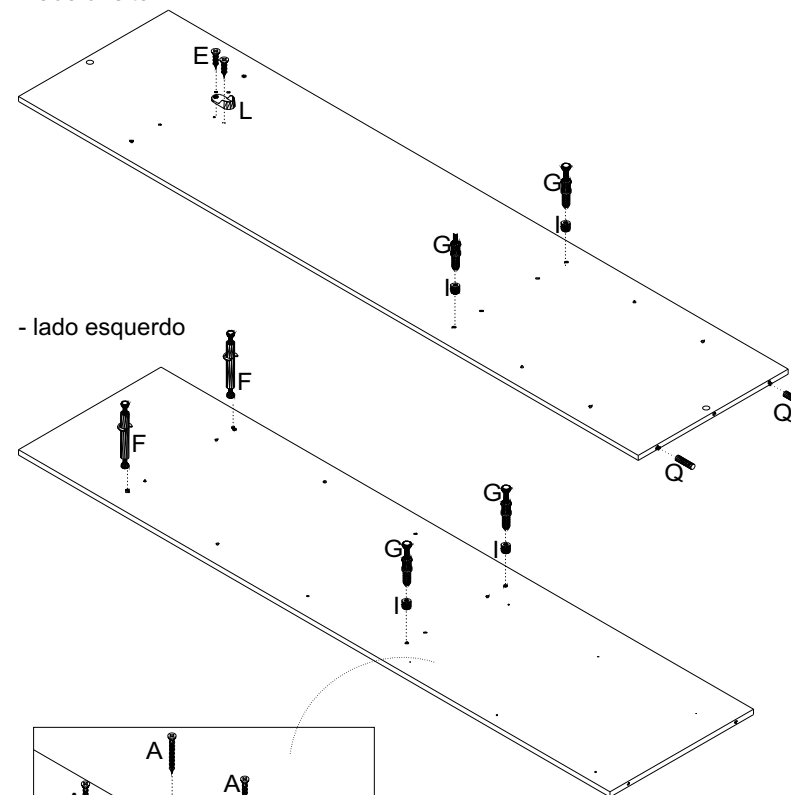

- lado esquerdo

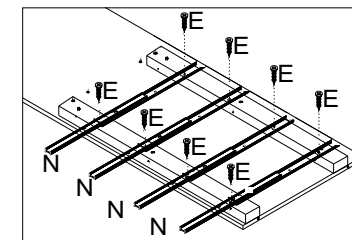
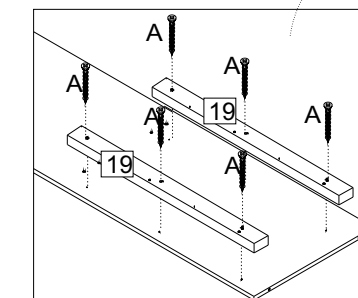
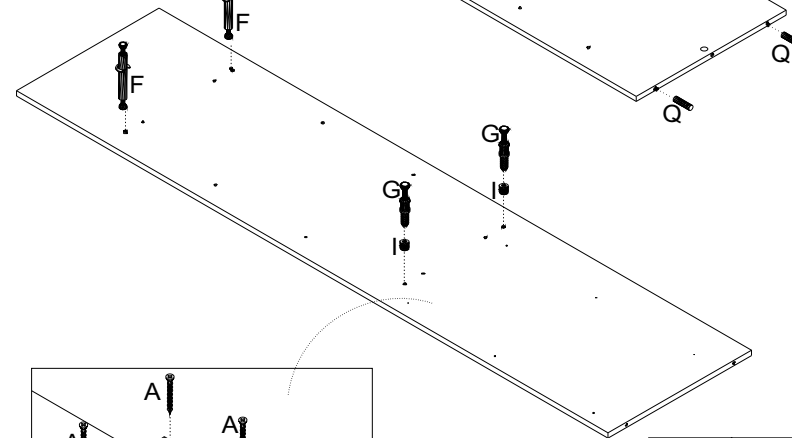

Colocar trilho superior (AB) no chapéu (4) e trilho Inferior (AD) na base (5)

usar parafuso (E)

