

Puppi Móbile
Rua Ema Tanner de Andrade, 965
Vila Ferrari - Campo Largo - Paraná
e-mail: puppimobile@puppimobile.com.br
fone: (41) 3392-1626

MANUAL DE INSTRUÇÕES

COMODA CAPRI C/ PORTA
REF: 20656 C/ PUXADOR E PÉS MEL

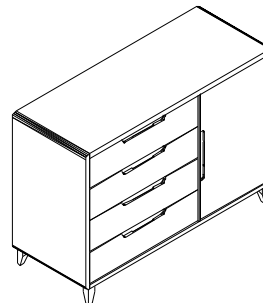











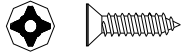
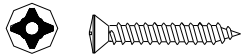

Linha Color
20656/07 - Navy
20656/09 - Cinza Gianduia
20656/11 - Rose

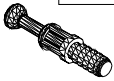

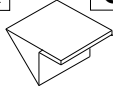
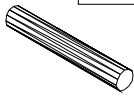
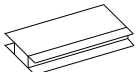
www.puppimobile.com.br

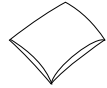
Medida C: 1315 L/C 920 P 515
Peso Suportado: 3Kg por gaveta

- 1. Leia atentamente todo o manual de instruções antes de iniciar a montagem.**
- 2. A montagem do produto deverá ser feita em superfície limpa e plana. Aconselhamos utilizar a própria embalagem para forrar o chão a fim de não danificar o produto.**
- 3. Reservar área livre p/ montagem do produto.**
- 4. Evitar batidas e contato com objetos cortantes.**
- 5. A abertura das gavetas devem ser feitas uma de cada vez para evitar tombamento.**
- 6. Quando a gaveta estiver aberta, não se apoiar sobre a mesma.**
- 7. Fixar o kit anti-tombamento de segurança para evitar acidente.**

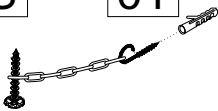
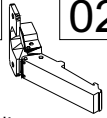
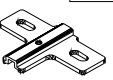
| | | | |
|---|--|---|---|
| A 05  Paraf. soberbão 7x70 cab chata | B 40  Paraf. 4x14 cab chata | C 08  Paraf. 3,5x35 cab flange | D 08  Paraf. 3,5x20 cab chata |
| E 15  Paraf. 3,5x12 cab chata | F 02  Suporte cabideiro | G 14  Tampa minifix | H 26  Paraf. minifix M6x7,5 |
| I 26  Tambor minifix | J 26  Buchas minifix | K 08  Fixador fundo de gaveta | L 50  Cavilha 8x40 |
| M 1  Perfil "H" 1265mm | N 36  Pregos | O 02  Sachê de cola | P 04  Corrediça telescópica (PAR) |
| Q 12  Tapa furo de 15mm | R 06  Suporte prateleira | S 01  Kit anti-tombamento | T 02  Dobradiça caneco 35mm |
| U 02  Calço dobradiça | | | |

Porta (03)

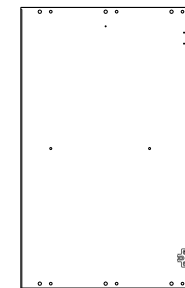
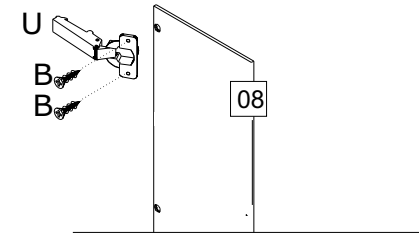

A marcação superior do calço da dobradiça não existe na lateral (conforme figura), coloque o calço na parte de baixo para ser guia e alinhar.

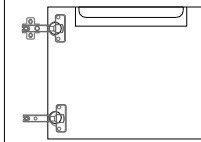

Kit anti-tombamento

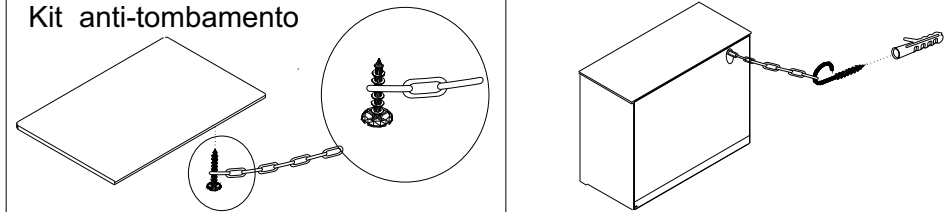

- 1º passo - antes de prender o encosto fixar a corrente com parafuso no lado de baixo do tampo
- 2º passo - fazer um furo no encosto e passar a corrente
- 3º passo - fixar a outra extremidade do kit: fazer furação na parede com broca 6mm e colocar o gancho na bucha e engatar a corrente.

Encosto (14 e 15)

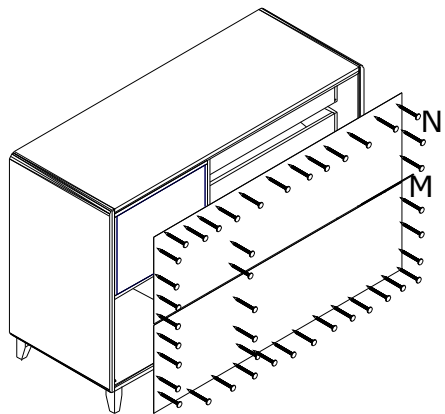

Montar gavetas

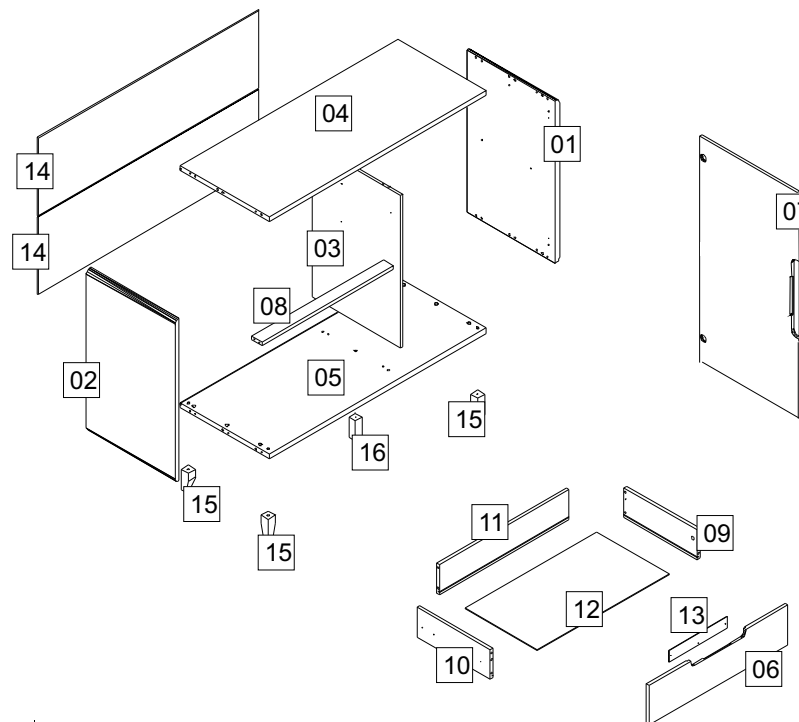
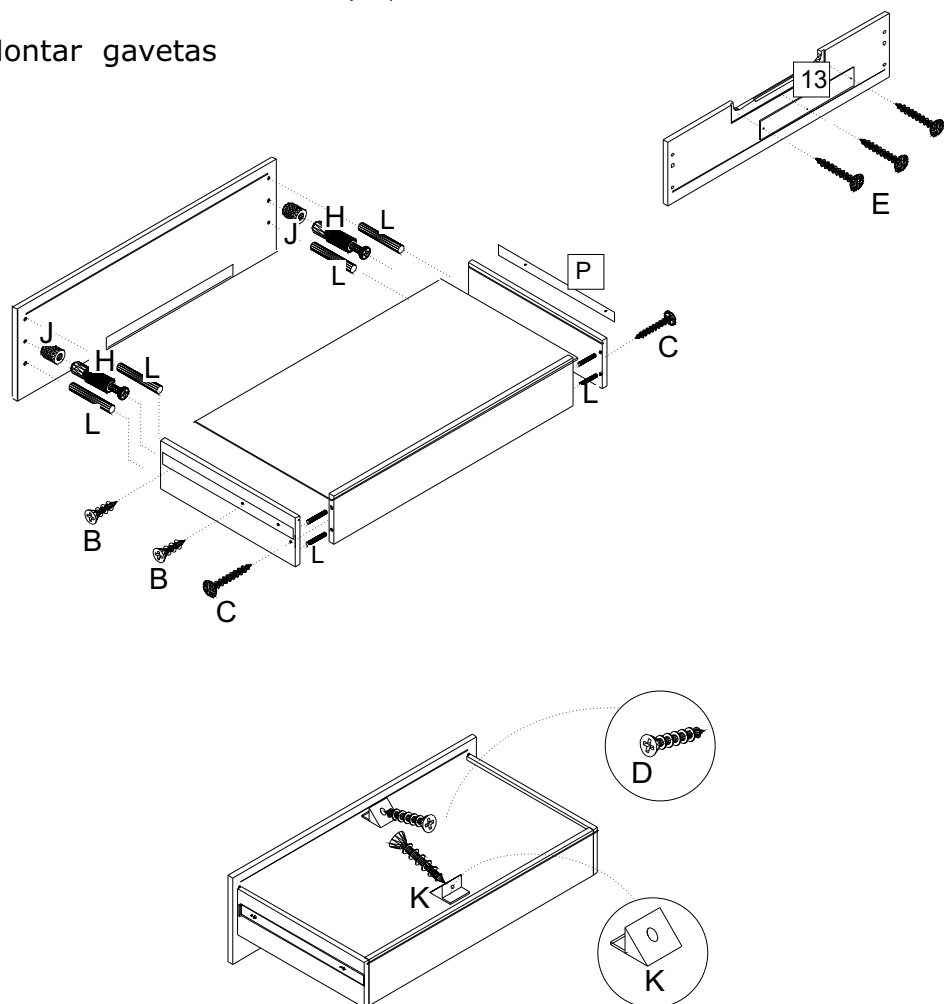

| Item | COMPONENTES | Quant. |
|------|--------------------|--------|
| 1 | LATERAL DIREITA | 1 |
| 2 | LATERAL ESQUERDA | 1 |
| 3 | DIVISÓRIA | 1 |
| 4 | TAMPO | 1 |
| 5 | BASE | 1 |
| 6 | FRENTE GAVETA | 4 |
| 7 | PORTA | 1 |
| 8 | TRAVESSA | 1 |
| 9 | LATERAL DIR GAVETA | 4 |
| 10 | LATERAL ESQ GAVETA | 4 |
| 11 | TRASEIRA GAVETA | 4 |
| 12 | FUNDO GAVETÃO | 4 |
| 13 | ESPELHO PUXADOR | 5 |
| 14 | ENCOSTO | 2 |
| 15 | PÉ | 4 |
| 16 | PE CENTRAL | 1 |

Montar Lateral direita (01)

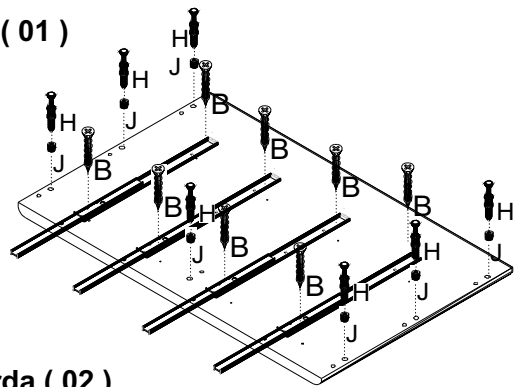

Montar Lateral esquerda (02)

- Item (T) serve de suporte para o nicho

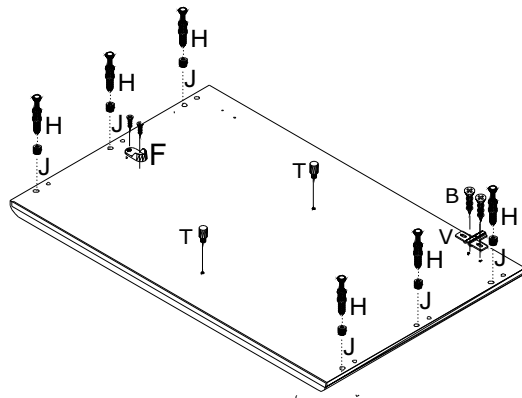

Divisória (03)

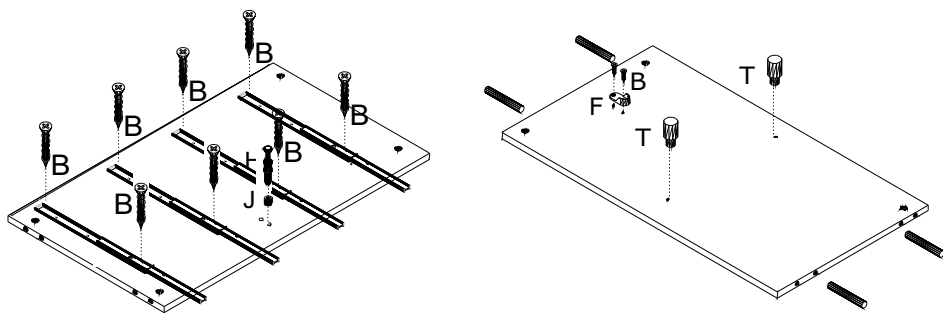

Tampo (04)

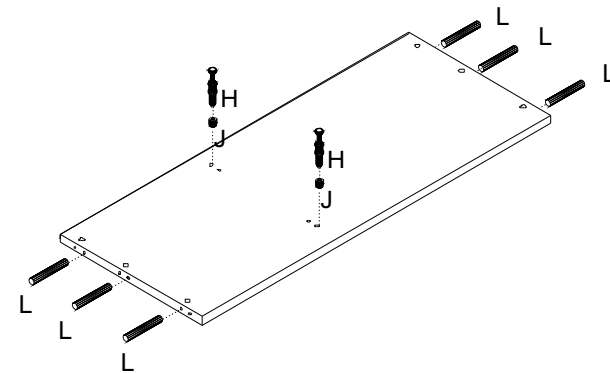

Base (05)

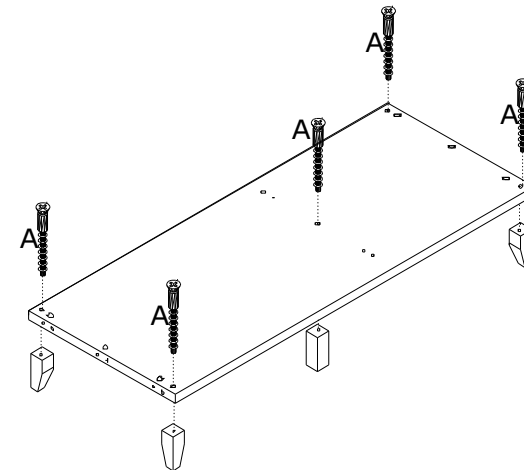

Fixar travessa (08)

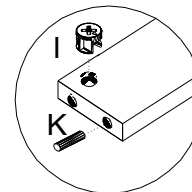

Para travessa usar tambor mini fixi (F) , e cavilha (K)