

## Montagem do sistema de porta

Freio  
Fixar com Parafuso 3,5x25 cab  
flange(C )

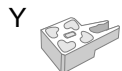

Carro deslizador

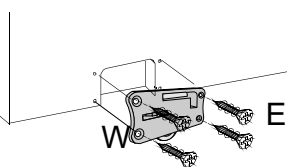

Guia  
Parafuso 3,5x 20 cab  
chata (D)

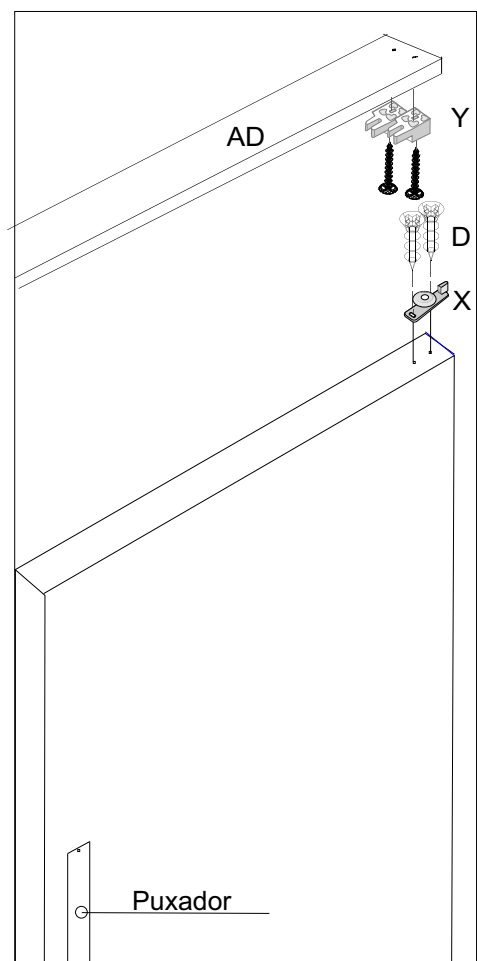
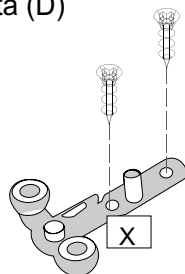

## Puppi Móbile

Rua Ema Tanner de Andrade, 965  
Vila Ferrari - Campo Largo - Paraná  
e-mail: puppimobile@puppimobile.com.br

## MANUAL DE INSTRUÇÕES

Roupeiro White 1,40  
REF.: 10629

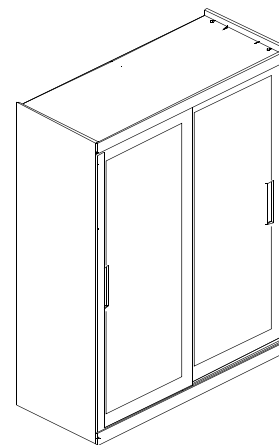

PUPPI  
MOBILE

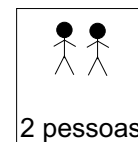

2 pessoas





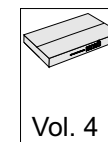







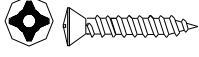
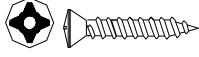
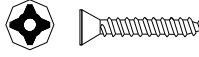
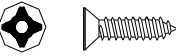











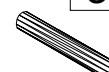

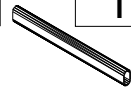

Aproximadamente:  
2 horas

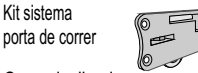

Vol. 4

Medida A 1403 L/C 2250 P598

1. Leia atentamente todo o manual de instruções antes de iniciar a montagem.
2. A montagem do produto deverá ser feita em superfície limpa e plana. Aconselhamos utilizar a própria embalagem para forrar o chão a fim de não danificar o produto.
3. Reservar área livre p/ montagem do produto.
4. Evitar batidas e contato com objetos cortantes.

<b>A</b> 12  Paraf. 4,0x45 cab chata	<b>B</b> 6  Paraf. 3,5x35 cab flange	<b>C</b> 10  Paraf. 3,5x25 cab flange	<b>D</b> 14  Paraf. 3,5x20 cab chata
<b>E</b> 103  Paraf. 4,0x14 cab chata	<b>F</b> 2  Paraf. minifix duplo	<b>G</b> 30  Paraf. minifix m6x7,5	<b>H</b> 4  Parafuso M4 x10 cab. Flange
<b>I</b> 30  Bucha minifix	<b>J</b> 34  Tampa minifix	<b>K</b> 34  Tambor minifix	<b>L</b> 2  Suporte cabideiro
<b>M</b> 6  Fixador fundo de gaveta	<b>N</b> 12  Correção telescópica 400mm (PAR)	<b>O</b> 2  Trapézio	<b>P</b> 40  Fixador para costa de roupeiro
<b>Q</b> 98  Cavilha 8x40	<b>R</b> 120  Pregos 8x8mm	<b>S</b> 1  Tubo oblongo 872mm	<b>T</b> 2  Puxador 256mm
<b>U</b> 2  Sachê de cola	<b>V</b> 8  Sapata "U" 15mm	<b>W</b> 4  Kit sistema porta de correr Carro deslizador	<b>X</b> 4  Guia
<b>Y</b> 4  Freio	<b>Z</b> 1  Chave de boca	<b>AA</b> 4  Perfil desempenador 2090mm	<b>AB</b> 1  Trilho inferior med. 1769mm
<b>AC</b> 1  Trilho superior med. 1769mm	<b>AD</b> 9  Cantoneira	<b>AE</b> 6  Tapa furo 10mm	

### Colocar vista superior ( 20 )

- colocar cavilhas e minifix nas extremidades da vista
- Colocar vista inferior ( 21 ) e vista lateral ( 22 ) com cavilha ( Q ) e cola ( U )

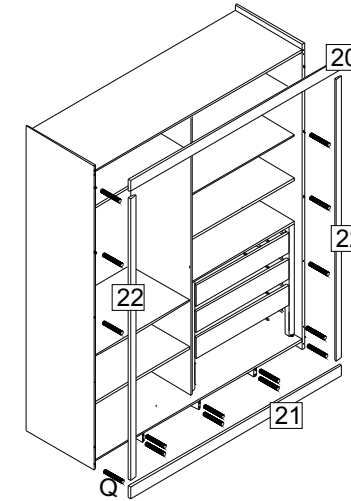

### -montagem de gavetas

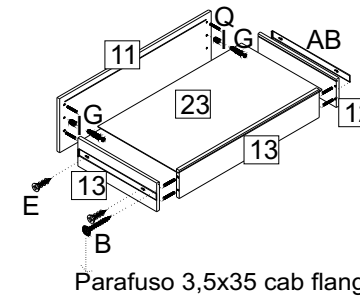

Parafuso 3,20 cab chata (D)

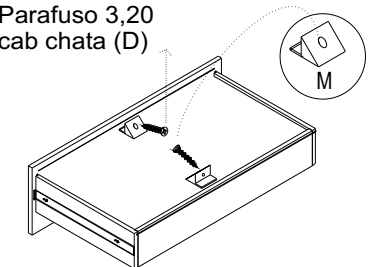

### -Portas

Colocar perfil desempenador (AA) nas portas com parafusos 4x14 cab chata (E)  
Puxador (T) com parafuso (H)

Ao colocar o puxador, utilizar parafuso H.

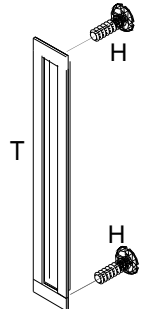
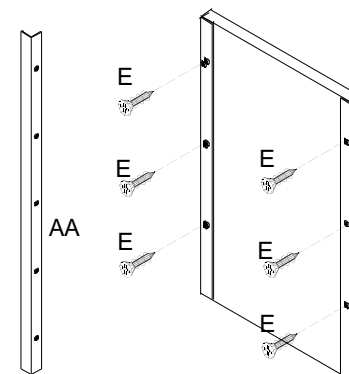

### Montar o roupeiro.

- iniciar com uma das laterais
- montar com a parte de trás para cima

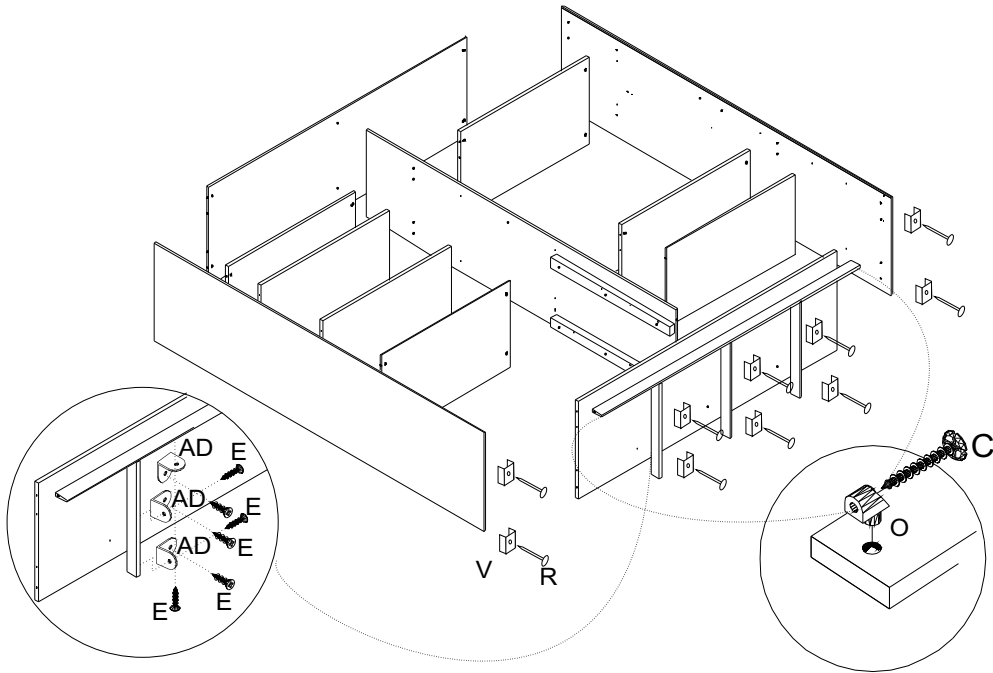

### Fixar encosto horizontal(25) e vertical(24)

- usar pregos (R) e fixador de encosto (P)
- deixar espaçamento de 12 cm de um prego ao outro.

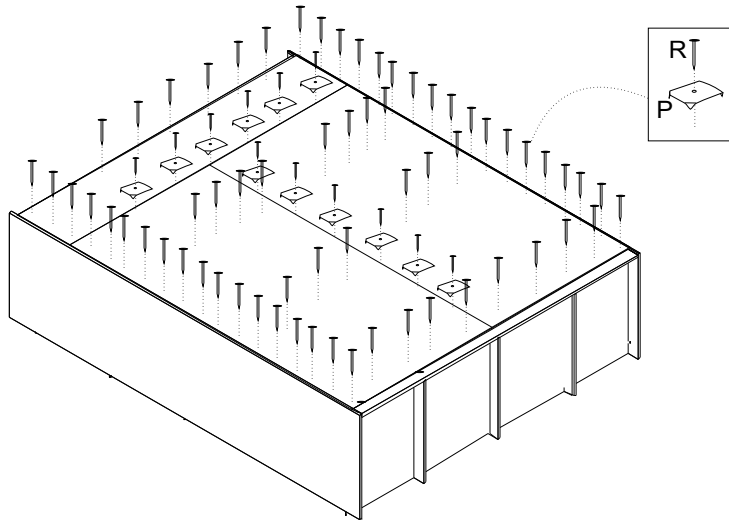

### LISTA DE PEÇAS

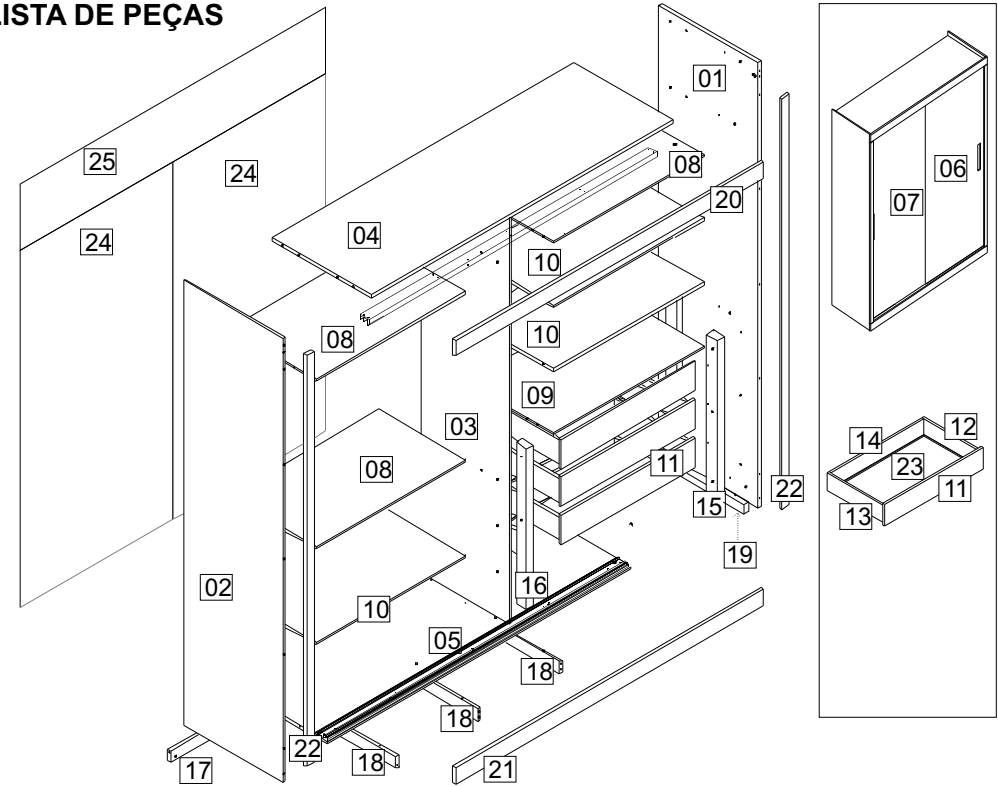

item	COMPONENTES	quant
1	LATERAL direita	1
2	LATERAL esquerda	1
3	DIVISÓRIA central	1
4	CHAPÉU	1
5	BASE	1
6	PORTA direita	1
7	PORTA esquerda	1
8	PRATELEIRA fixa c/ mini fix	3
09	PRATELEIRA fixa c/ mini fixc- sobre gavetas	1
10	PRATELEIRA c/ cavilha	3
11	FRENTE de gaveta	3
12	LATERAL direita de gaveta	3
13	LATERAL esquerda de gaveta	3
14	TRASEIRA de gaveta	3
15	MONTANTE distanciador de corrediça direita	2
16	MONTANTE distanciador de corrediça esquerda	2
17	RODAPÉ traseiro	1
18	REFORÇO RODAPÉ	3
19	REFORÇO para base	2
20	VISTA superior	1
21	VISTA inferior	1
22	VISTA lateral	2
23	FUNDO gaveta	3
24	ENCOSTO vertical	2
25	ENCOSTO horizontal	1

### Montar Lateral direita ( 01 )

usar parafuso minifix (G) bucha (I) parafuso 4,0x45 cab chata (A)

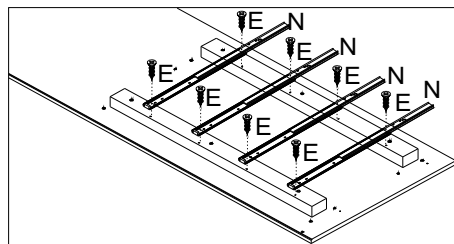
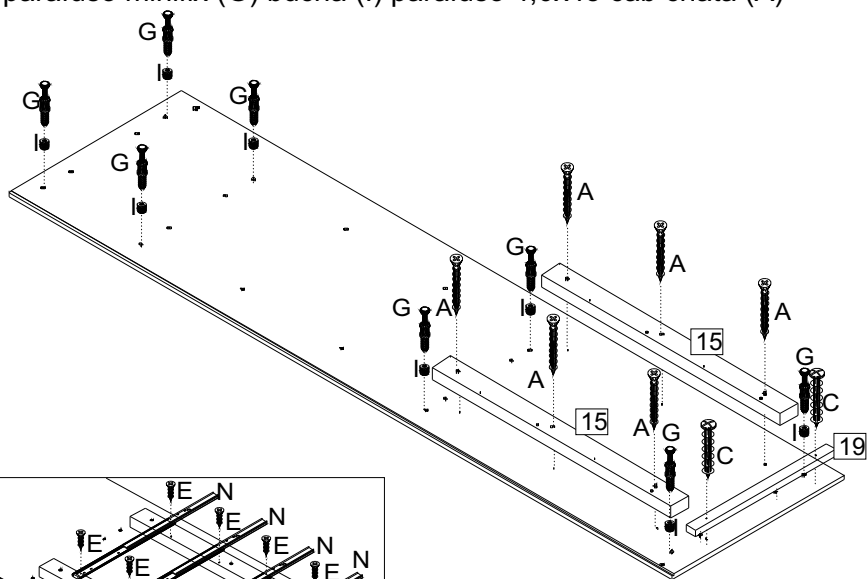

### Montar Lateral esquerda ( 02 )

usar parafuso minifix (G), bucha (I) e parafuso 3,5x25 cab flange (C)

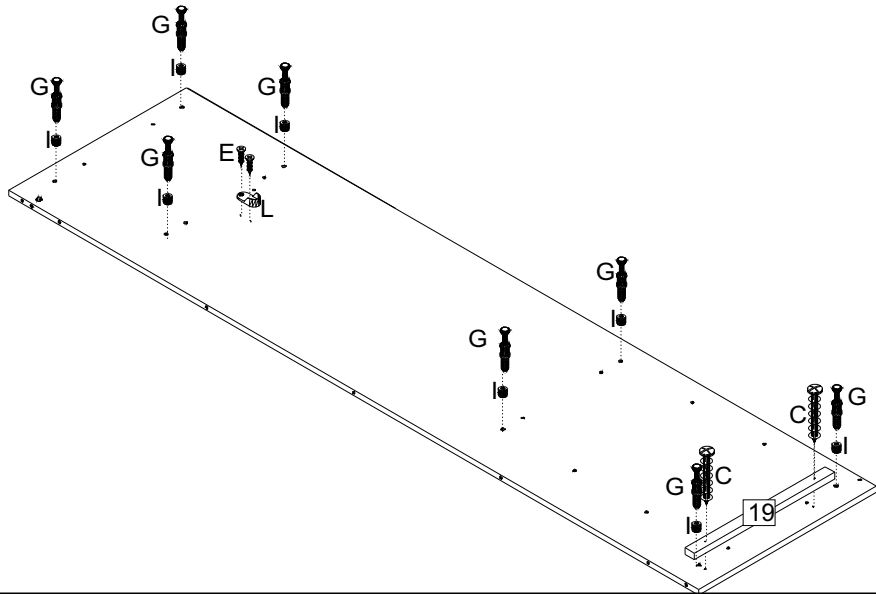

### Montar divisória direita (03) lado direito e esquerdo

-fixar ferragens no lado direito e esquerdo

- lado direito

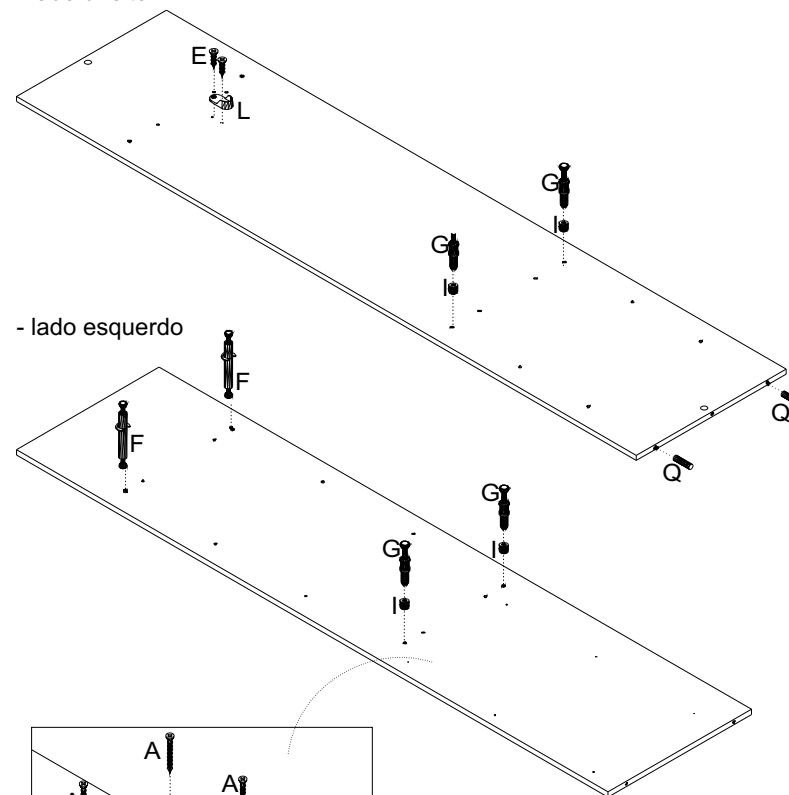

- lado esquerdo

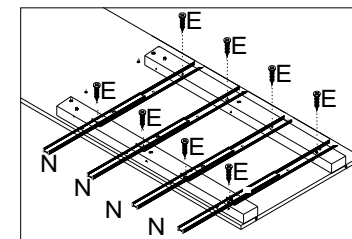
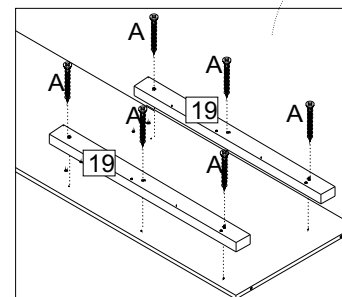

Colocar trilho superior (AB) no chapéu (4) e trilho Inferior (AD) na base (5)

usar parafuso (E)

