

Fixar moldura lateral e frontal

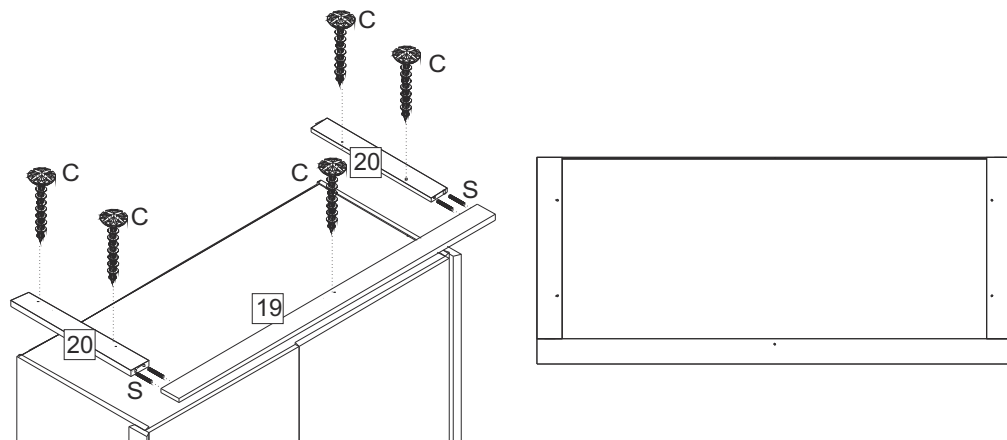

Montar gavetas

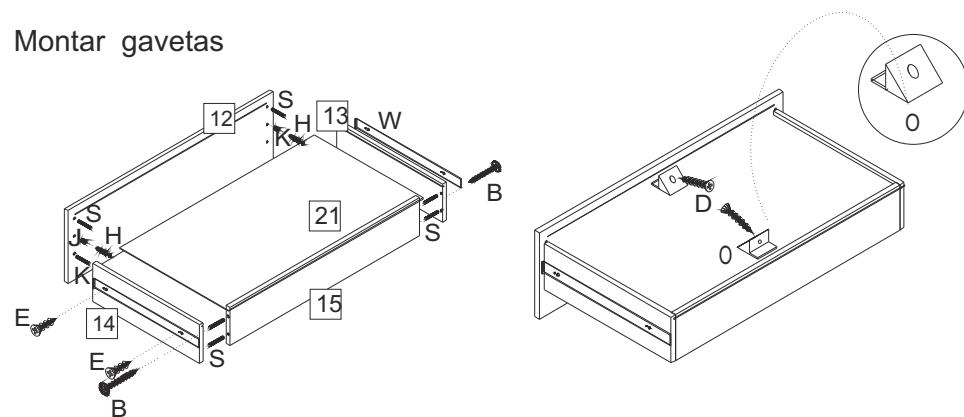

Fixar dobradiça e Puxador

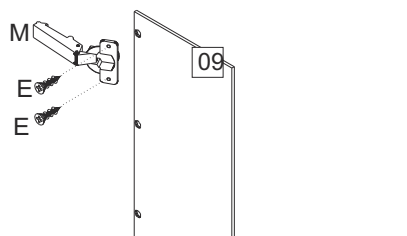

**Puppi Móbile**

Rua Ema Tanner de Andrade, 965  
Vila Ferrari - Campo Largo - Paraná  
e-mail: [puppimobile@puppimobile.com.br](mailto:puppimobile@puppimobile.com.br)  
fone: (41) 3392-1626

## MANUAL DE INSTRUÇÕES

**Roupeiro Nordic**

**REF.:10707**

**REF.:10707/07 - Navy**

**REF.:10707/09 - Cinza Gianduia**

**REF.:10707/10 - Café com Leite**

**REF.:10707/11 - Rose**

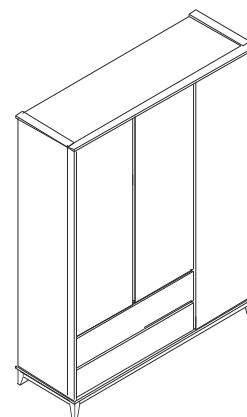

**PUPPI**  
MOBILE

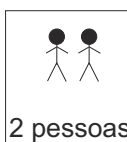

2 pessoas



Aproximadamente:  
2horas

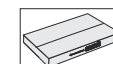











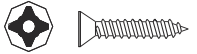

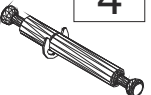
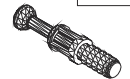



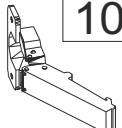

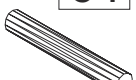

Vol.3

Medida A 2115 L/C 1651 P 540

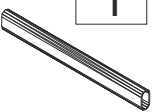
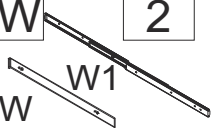
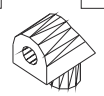
1. Leia atentamente todo o manual de instruções antes de iniciar a montagem.
2. A montagem do produto deverá ser feita em superfície limpa e plana. Aconselhamos utilizar a própria embalagem para forrar o chão a fim de não danificar o produto.
3. Reservar área livre p/ montagem do produto.
4. Evitar batidas e contato com objetos cortantes.

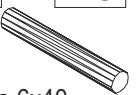
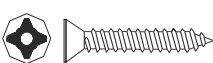
Ferragens

<b>A</b>	<b>7</b>	<b>B</b>	<b>4</b>	<b>C</b>	<b>15</b>	<b>D</b>	<b>4</b>
							
Parafuso soberbo 7x50		Paraf. 3,5x35 cab flange		Paraf. 3,5x25 cab flange		Paraf. 3,5x20 cab chata	
<b>E</b>	<b>56</b>	<b>F</b>	<b>10</b>	<b>G</b>	<b>4</b>	<b>H</b>	<b>24</b>
							
Paraf. 4x14 cabec chata		Paraf. 4x12cabec chata		Paraf. minifix duplo		Paraf. minifix m6x7,5	
<b>I</b>	<b>32</b>	<b>J</b>	<b>32</b>	<b>K</b>	<b>24</b>	<b>L</b>	<b>2</b>
							
Tambor minifix		Tampa minifix		Bucha minifix		Suporte cabideiro	
<b>M</b>	<b>10</b>	<b>N</b>	<b>10</b>	<b>O</b>	<b>4</b>	<b>P</b>	<b>30</b>
							
Dobradiça AL6 caneco 35mm		Calço dobradiça "0"		Fixador fundo de gaveta		Fixador para costa	
<b>Q</b>	<b>10</b>	<b>R</b>	<b>2</b>	<b>S</b>	<b>64</b>	<b>T</b>	<b>85</b>
							
Tapa furo 10mm		Sachê de cola		Cavilha 8x40		Pregos 8x8mm	
<b>U</b>	<b>1</b>	<b>W</b>	<b>2</b>	<b>X</b>	<b>6</b>	<b>Y</b>	<b>10</b>
							
Tubo oblongo 1042mm		Corrediça telescópica (PAR)		Trapézio		Paraf. 3,5x12 cabec chata	
<b>Z</b>	<b>16</b>	<b>AA</b>	<b>12</b>	<b>AB</b>	<b>1</b>		
							
Cavilha 6x40		Paraf. 3,5x40cab chata		Perfil "H" 1946mm			

Fixar encosto

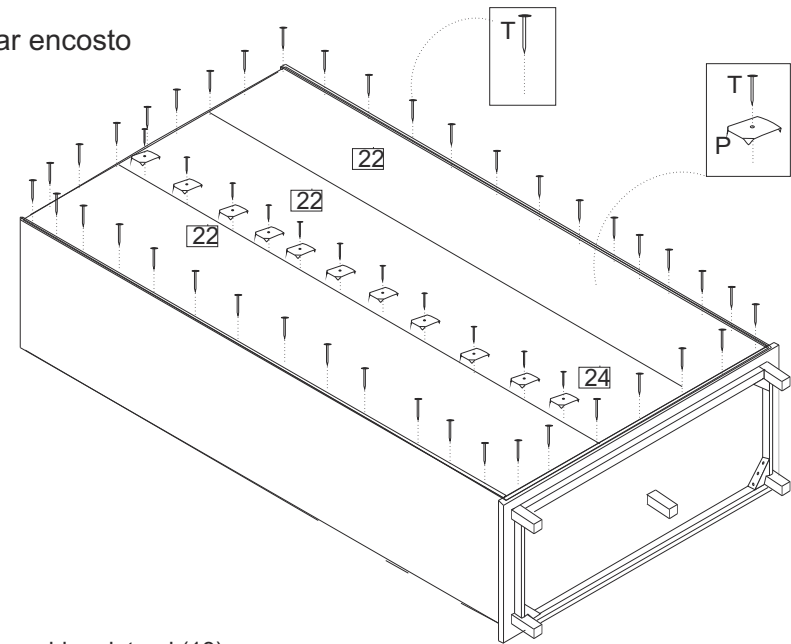

Fixar moldura lateral (18)

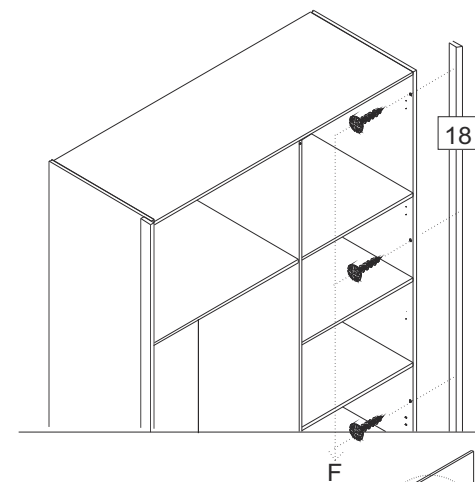

**moldura -**  
conforme desenho esquemático  
alinhar com as vistas e portas

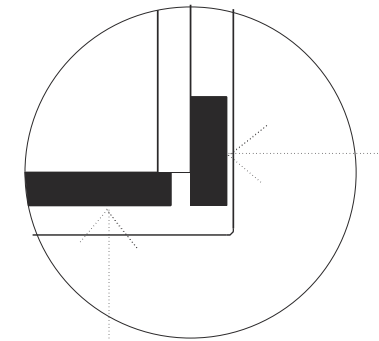

Porta

Fixar vista puxador na porta

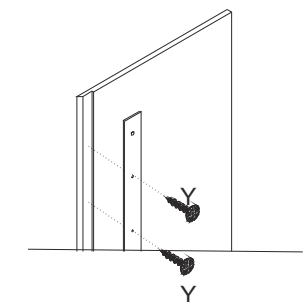
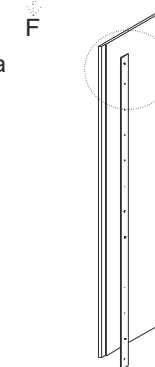

## Chapéu (4)

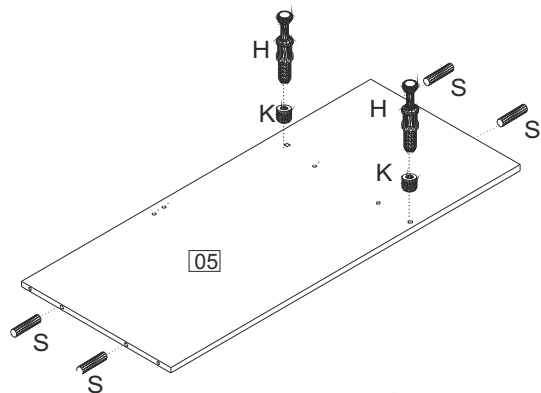

## Prateleira grande (6)

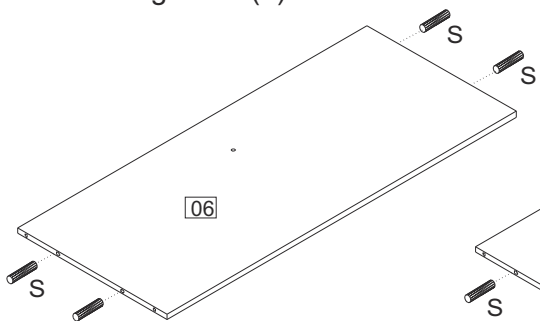

## Base central (7)

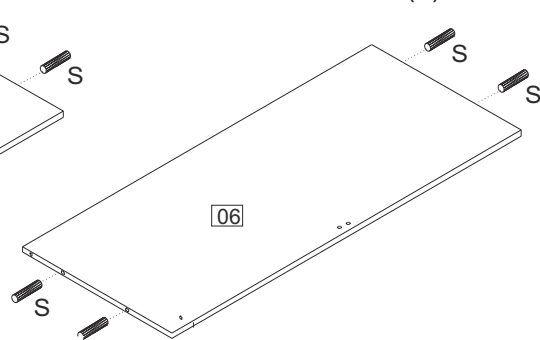

## Prateleiras ( 8 e 9)

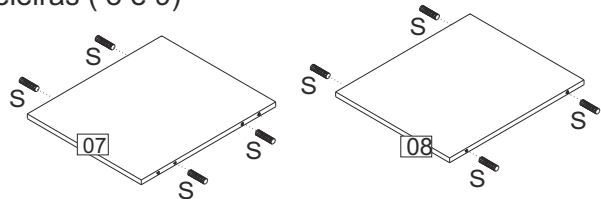

## Montagem

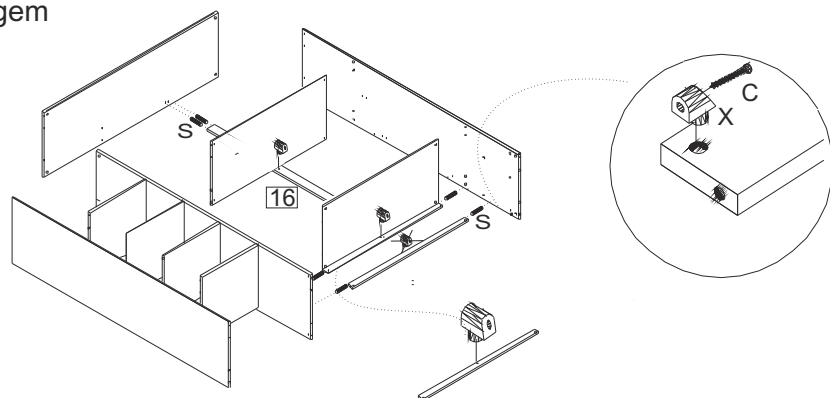

Utilizar trapézio (X) no centro somente no montante horizontal superior

## LISTA DE PEÇAS

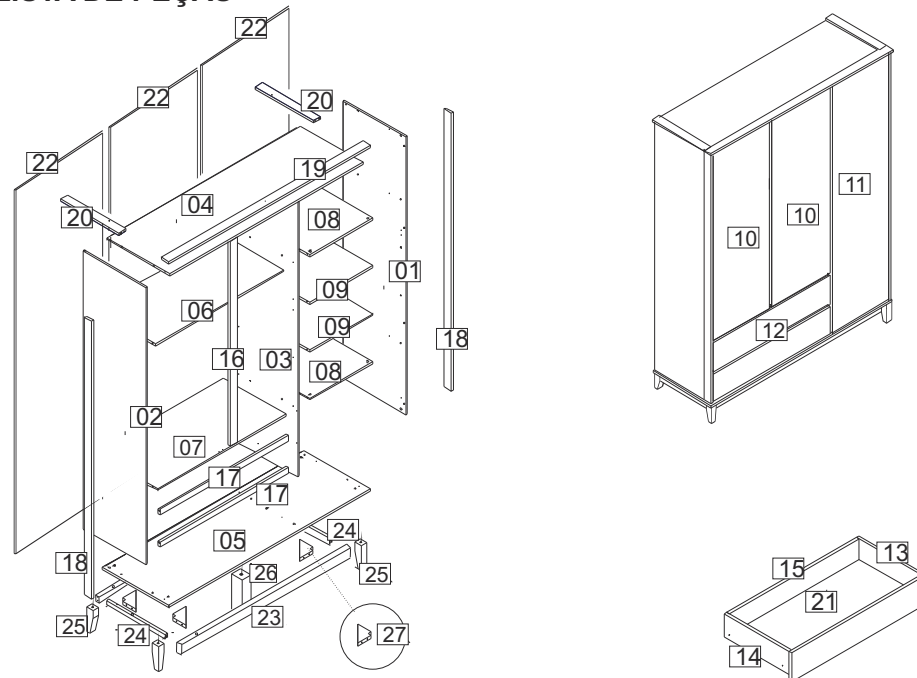

ITEM	DESCRIÇÃO	quant
1	LATERAL DIREITAL	1
2	LATERAL ESQUERDA	1
3	DIVISÓRIA	1
4	CHAPÉU	1
5	BASE	1
6	PRATELEIRA GRANDE	1
7	BASE CENTRAL	1
8	PRATELEIRA C/ MINI FIX	2
9	PRATELEIRA C/ CAVILHA	2
10	PORTA MÉDIA	2
11	PORTA GRANDE	1
12	FRENTE DE GAVETA	2
13	LATERAL DIR GAVETA	2
14	LATERAL ESQ. GAVETA	2
15	TRASEIRA DE GAVETA	2
16	VISTA INTERNA FRONTAL	1
17	MONTANTE HORIZONTAL	2
18	MOLDURA LATERAL	2
19	MOLDURA SUPERIOR FRONTAL	1
20	MOLDURA SUPERIOR LATERAL	2
21	FUNDO DE GAVETA	2
22	ENCOSTO	3
23	RODAPÉ FRONTAL/TRASEIRO	2
24	RODAPÉ LATERAL	2
25	PÉS	4
26	PÉ CENTRAL	1
27	SUPORTE DE SUSTENTAÇÃO DOS PÉS	4

Montar Lateral direita ( 01 )

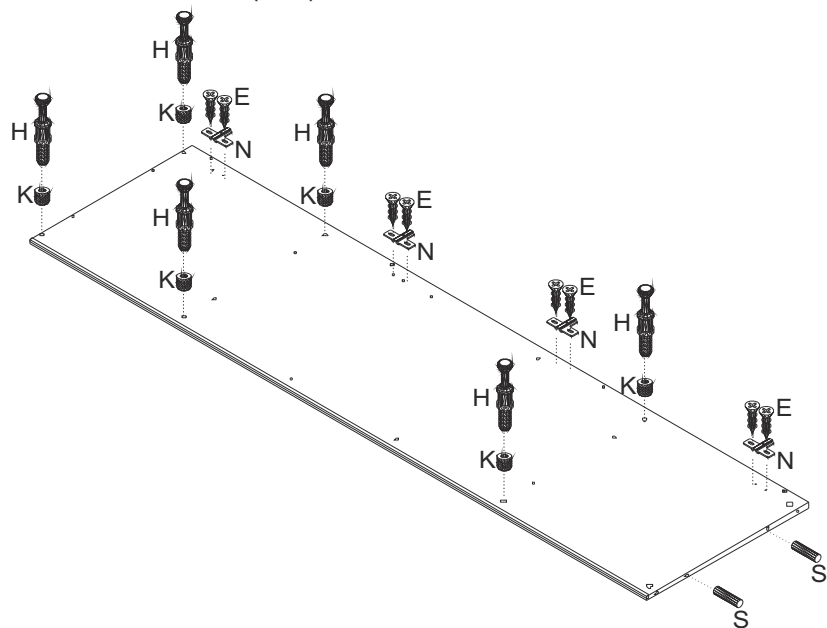

Montar Lateral esquerda ( 02 )

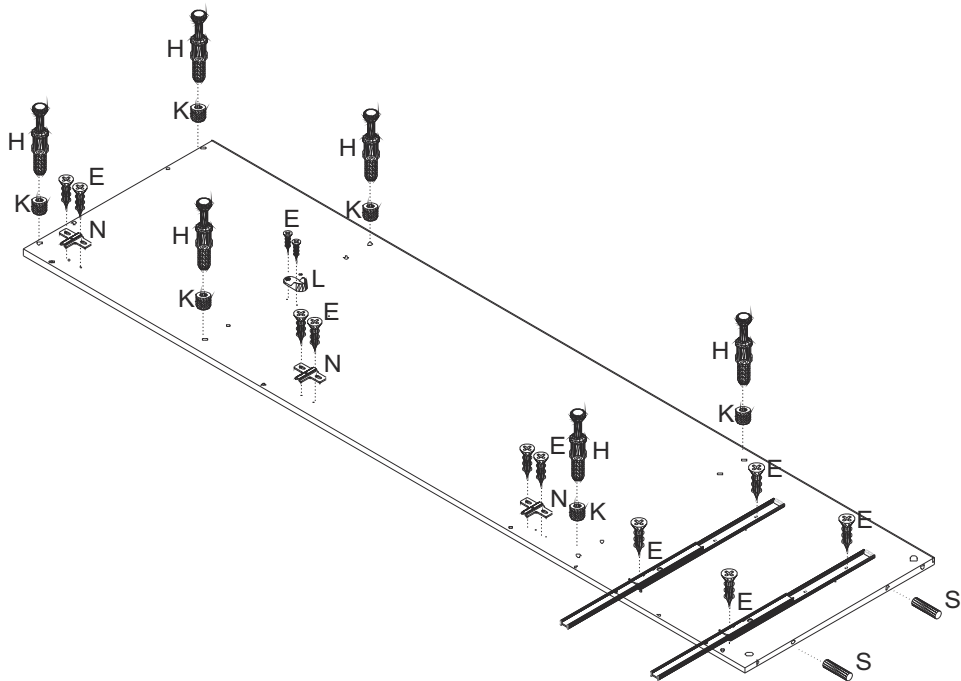

Divisória (03)

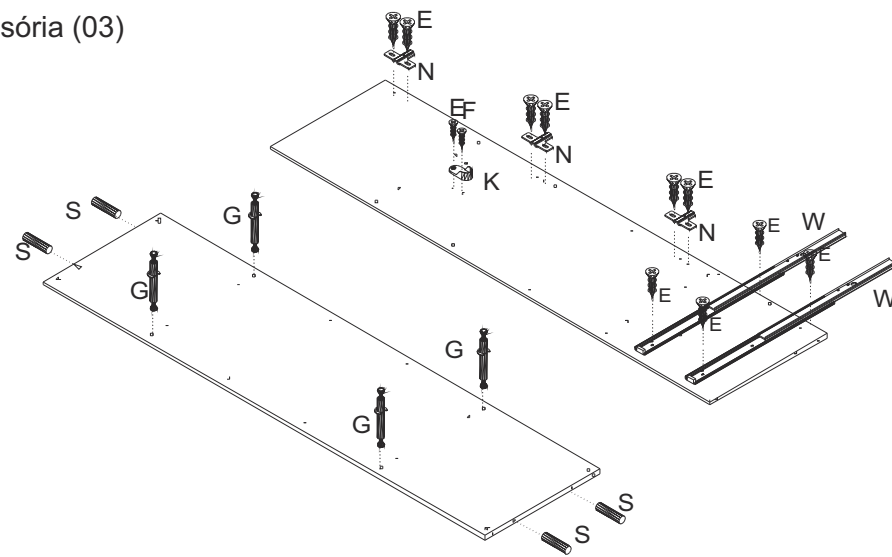

Montar a base(5) no pé  
- utilizar cola nas cavilhas

